

SPECIFICATIONS
L1505UHNL/L1755UNL

MODEL NUMBER	EB-L1505UHNL	EB-L1755UNL
Projection Technology	RGB liquid crystal shutter projection system (3LCD)	
Specifications of Main Parts		
LCD	Size	1.03" (D10)
	Native Resolution	WUXGA (1920 x 1200)
	Type	Laser Diode
Lightsource	Type	Laser Diode
	Life (Normal / Extended)	20,000 / 30,000 hours
Projection Lens (Using Optional ELPLM15)		
Type	Power Zoom / Power Focus / Power Shift	
F-Number	1.8 - 2.3	
Focal Length	36.0 - 57.4 mm	
Zoom Ratio	1.61	
Throw Ratio	1.57 - 2.56 (Wide to Tele)	
Lens Exchange	Yes	
Lens Shift	Mode	Powered
	Vertical (Up/Down)	±60%
Horizontal (Left/Right)	±18%	
Screen Size (Projected Distance)		
Zoom: Wide	60" - 1,000" [1.99 - 34.43 m]	
Zoom: Tele	60" - 1,000" [3.26 - 55.63 m]	
Brightness¹		
White Light Output (Normal / Extended)	12,000lm / 8,400lm	15,000lm / 10,500lm
Colour Light Output	12,000lm	15,000lm
Contrast Ratio		
	2,500,000:1	
Geometric Correction		
Vertical / Horizontal Keystone	±45° / ±30° (Zoom: Tele) (with Standard Lens)	
Quick Corner	Yes	
Arc	Yes	
Curve Surface	Yes	
Point Correction	Yes	
Corner Wall	Yes	
Geometry Correction Memory	Yes	
Connectivity		
Analog Input	D-Sub 15Pin	1 (Blue)
	5BNC	1
Digital Input	DVI-D	1
	HDMI	1
	SDI	1x
	HDBaseT	RJ45 x 1
Output Terminal	D-Sub 15Pin	1
Audio Input	Stereo Mini Jack	3
Audio Output	Stereo Mini Jack	1
Others	USB Type A	1 (for Wireless LAN, Firmware Update, Copy OSD Settings)
	USB Type B	1 (for Firmware Update, Copy OSD Settings)
Control I/O	RS-232C	D-Sub 9Pin x 1
	Remote Control Input	Stereo Mini Jack x 1
Network	Wired LAN	RJ45 x 1
	Wireless	Optional
Wireless Specification		
Supported Speed For Each Mode	IEEE 802.11b: 11Mbps ² IEEE 802.11g: 54Mbps ² IEEE 802.11n: 130Mbps ²	
Wireless LAN Security	Quick Mode: OPEN, WPA2-PSK Advanced Mode: OPEN, WPA/WPA2-PSK, WPA/WPA2-EAP Supported EAP Type: PEAP, PEAP-TLS, EAP-TLS, EAP-Fast, LEAP	
Operating Temperature		
	0 - 50 °C <32 - 122 °F> (Below 1,500m / 4,921ft) 0 - 45 °C <32 - 113 °F> [Above 1,500m / 4,921ft - 3,048m / 10,000ft (with high altitude mode)]	
Operating Altitude		
	0 - 3,048 m <0 - 10,000 ft> (over 1,500m / 4,921ft : with high altitude mode)	
Direct Power On / Off		
	Yes	
Start-Up Period		
	Less than 7 seconds, Warm-up Period: 30 seconds	
Cool Down Period		
	Instant Off	
Air Filter		
Type	High Efficiency Filter	
Maintenance Cycle (Normal / Extended)	20,000 / 30,000 hours ³	
Power Supply Voltage		
	100 - 240 V AC ±10%, 50/60 Hz	
Power Consumption (220 - 240V)		
Laser Diode (Normal / Extended)	908W / 597W	1024W / 647W
Standby (Network / Energy Saving)	2.0W / 0.3 W	
Dimension Excluding Feet (D X W X H)		
	492 x 586 x 185 mm	
Weight (Including Standard Lens)		
	Approx. 23.7 kg	Approx. 24.1 kg
Weight (Excluding Standard Lens)		
	Approx. 21.9 kg	Approx. 22.3 kg
Fan Noise (Normal / Quiet)		
	37dB / 30dB	

¹ Colour brightness (colour light output) and white brightness (white light output) will vary depending on usage conditions. Colour light output measured in accordance with IDMS 15:4; white light output measured in accordance with ISO 21118.
² Maximum speed and range is achievable when used with same enhanced mode technology. Actual data rates, features and performance may vary depending on your computer system, the environment and other factors.
³ 20,000H life for laser light source : Approximate time until brightness decreases 50% from first usage. Measured by acceleration test assuming use of 0.04 - 0.20 mg/m³ of particulate matter. Time varies depending on usage conditions and environments. Replacement of parts other than the light source may be required in a shorter period.

EPSON
EXCEED YOUR VISION

Supplied Accessories

Power Cable
HDMI Cable Clamp
Remote Control with 2 x AA Battery
Cable Cover
User's Manual CDROM

Optional Accessories

Air Filter: ELPAF51
Wireless LAN Card: ELPAP10
HDBaseT Transmitter: ELPHD01
Remote Control Cable Set: ELPKC28
Ceiling Mount: ELPMB47 / ELPMB48

Optional Lenses

Ultra Short Throw Lens: ELPLX02
Zoom Lens: ELPLU03S / ELPLU04 / ELPLW05 / ELPLW06 / ELPLM10 / ELPLM11 / ELPLM15 / ELPLL08

EB-L1505UHNL / EB-L1755UNL



©2019 Epson Singapore Pte Ltd. All Rights Reserved. Reproduction in part or in whole, without the written permission from Epson, is strictly prohibited.

EPSON and EXCEED YOUR VISION are registered trademarks of Seiko Epson Corporation.

All other product names and other company names used herein are for identification purposes only and are the trademarks or registered trademarks of their respective owners.

Epson disclaims any and all rights in those marks. Projected images shown herein are simulations. The actual product design and contents may vary. Specifications are subject to change without notice and may vary between countries. Please check with local Epson offices for more information.

Apple, iPad and iPhone are trademarks of Apple Inc., registered in the U.S. and other countries. App Store is a service mark of Apple Inc.

Android is a trademark of Google Inc.

Dealer's Stamp

Information correct at time of printing
Printed December 2019

HIGH BRIGHTNESS LASER PROJECTORS
EB-L1060UNL/L1070UNL/L1495UNL
EB-L1505UHNL/L1755UNL

EPSON
EXCEED YOUR VISION



**MORE THAN
MEETS THE EYES
WITH LASER
PROJECTIONS.**

The Epson EB-L1000 series projector is designed to deliver unyielding laser performance, from any position to most surfaces, up to 20,000¹ long lasting hours for the laser light source – maintenance-free². Project 4K enhanced resolutions³ in confident colours with the intuitive colour correction system that compensates for uneven colour surfaces and screens. Every component is skilfully innovated with attention to detail in mind, including the integrated 3LCD technology that will provide you with stunning colour brightness for quality images.



EB-L1060UNL / L1070UNL



EB-L1495UNL / L1505UHNL / L1755UNL

[f](#) EpsonSingapore [@epsonsingapore](#) [EpsonSoutheastAsia](#) [Epson Singapore](#)

For latest specifications, visit www.epson.com.sg/projectors or call +65 800 120 5564.

Epson Singapore Pte Ltd 1 Harbourfront Place, #03-02 HarbourFront Tower One, Singapore 098633. Tel: (65) 6586-5500 Fax: (65) 6271-9755
Epson Customer Care Centre 108 Pasir Panjang Road, #04-08 Golden Agri Plaza, Singapore 118535. Epson Helpdesk: 800 120 5564. Operating hours: Monday - Friday, 9am - 6pm, Saturday, 9am - 1pm. Closed on Sunday and Public Holiday.



IT'S IN THE DETAILS.

With 3LCD panels, every projection gives you spectacular true colours.

¹ 20,000H life for laser light source: Approximate time until brightness decreases 50% from first usage. Measured by acceleration test assuming use of 0.04 - 0.20 mg/m³ of particulate matter.
² For laser light source only.
³ Only applicable to WUXGA models.

Unparalleled Performance

Bringing laser projection to the next level.

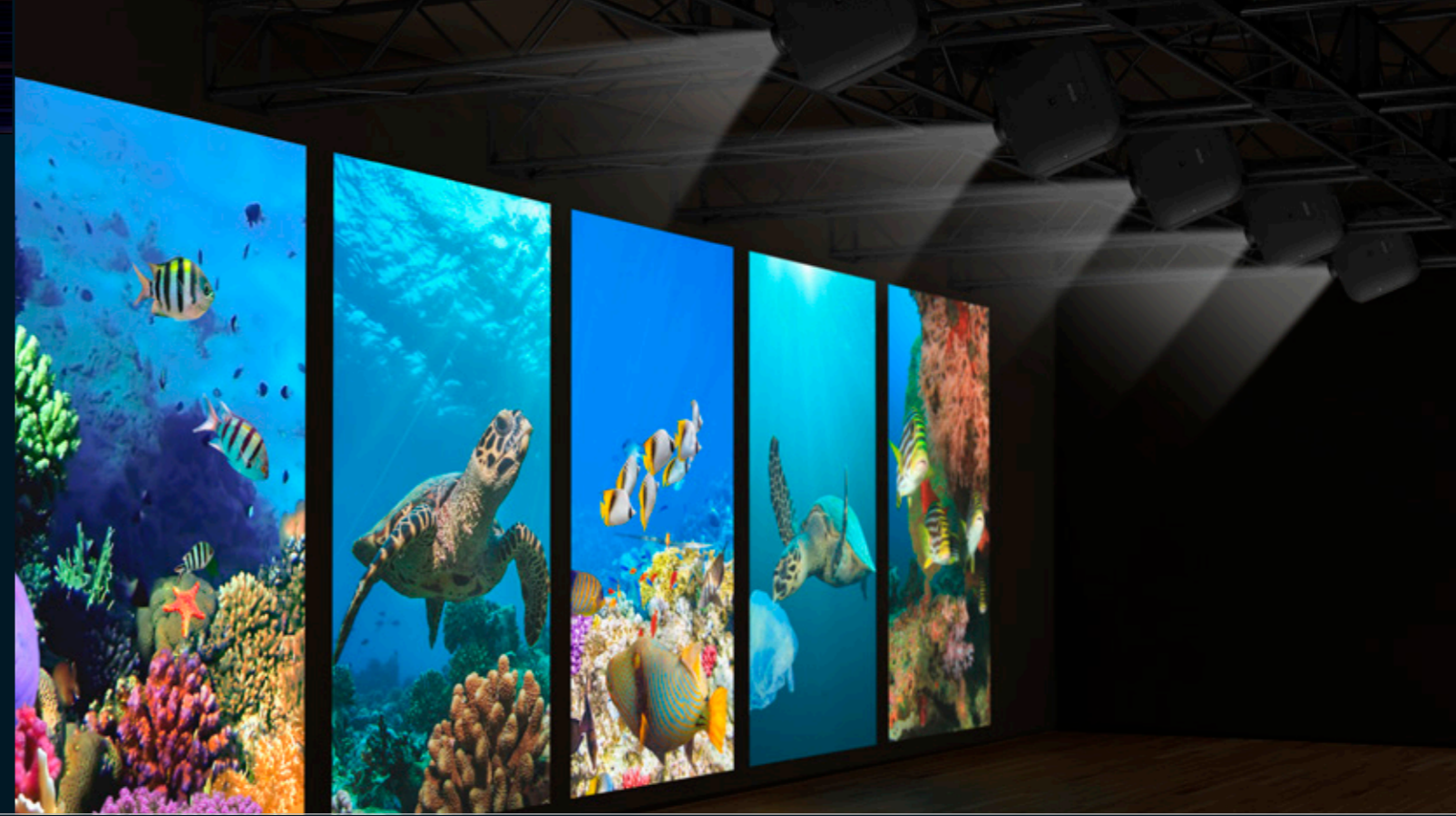

20,000 hours of maintenance-free** use

The newly designed laser light source delivers 20,000 hours* of maintenance-free** for the laser light source only. And with the advanced electrostatic filter having an equally long-lasting life, you enjoy peace of mind in using these highly reliable laser projectors.

Maintenance period of laser and lamp

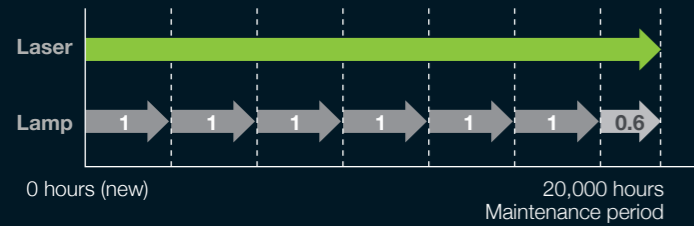

* 20,000H life for laser light source : Approximate time until brightness decreases 50% from first usage. Measured by acceleration test assuming use of 0.04 - 0.20 mg/m³ of particulate matter.
 ** For laser light source only. No maintenance for the light source required up to 20,000H.

Fine-tuning Brightness

The EB-L1000 series provides precise brightness adjustment in increments of 1%. This combined with the Constant Brightness mode maintains brightness at a given value to match the venue or subject to deliver astonishing picture quality.

Custom mode with constant brightness

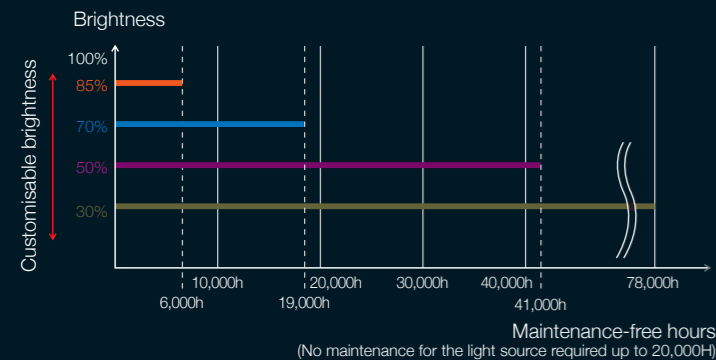

Inorganic LCD panels and phosphor wheel for outstanding reliability

Made of inorganic material, Epson's newly developed phosphor wheel offers superior light and heat resistance to deliver excellent reliability. By combining this with our inorganic LCD panels, we create laser projectors that project bright, vibrant images for extremely long periods.

Organic vs. Inorganic

	Inorganic (Glass, iron, aluminum, etc.)	Organic (Paper, wood, plastic, etc.)
Light - resistance	YES	NO
Heat - resistance	YES	NO

Unlike organic substances, inorganic substances do not contain carbon.

Worry-free projection

With multiple laser diodes to rely on, the screen won't go black even if one diode goes out. This eliminates the worry of the projector light burning out during mission-critical presentations.

Laser



The projector keeps working even when one light diode goes out.

Lamp

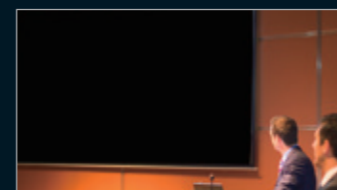

The screen goes black when the lamp burns out.

Adaptive Projection

EB-L1000 series can be rotated 360° in any direction — horizontally, vertically and rotationally — without any loss in image brightness. This makes it ideal for a wide range of applications, such as projecting onto ceilings and floors.



Well-balanced Whites

White light is created through combining the blue and yellow light beams. The advanced optical engine in the EB-L1000 series precisely adjusts the blue and yellow light to create brilliant white highlights, bringing a refreshing vibrancy to your images.



Conventional model

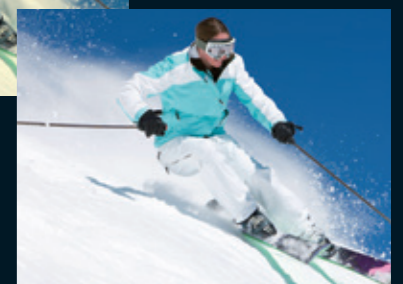

EB-L1000 Series

Simple and Compact Design

High-performance functions are accommodated in a simple and compact design. You can use this projector without worrying about the installation location.



Confident Colours Greater Details

Stunning, eye-catching images that make your presentations come to life.



WUXGA – Beyond Full HD Resolution*

With WUXGA resolution (1,920 x 1,200 pixels), you enjoy a sharp, clear display of Full HD video (1,920 x 1,080 pixels) images down to the smallest details even on large-screen projections for an incredible dynamic viewing experience.

* Only for WUXGA models only.



High-definition Images with 4K Enhancement Technology*

4K enhancement technology* shifts each pixel diagonally by 0.5 pixels, surpassing Full HD image quality to give you unbelievable sharpness, clarity and detail on all your presentations.

* Only applicable with WUXGA models.

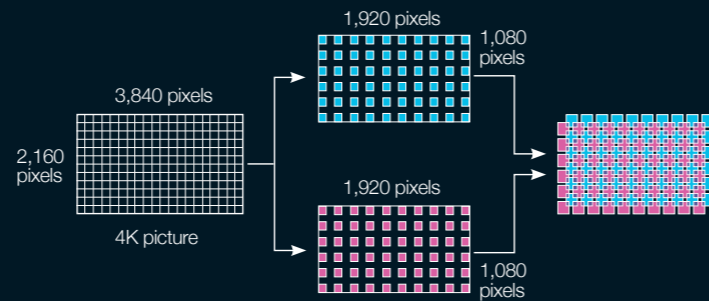

Note: This function can only be used when the input signal is 1080p or higher, and is recommended for projecting HD videos only, not documents.

Auto Colour Calibration with Built-in Camera*

The built-in camera detects projection that have become unevenly coloured over time, allowing the projector to automatically correct colour. It also detects subtle colour inconsistencies between multiple projectors. What's more, this function can be programmed to check colour manually or automatically at regular intervals to deliver stable image quality with minimum maintenance.



* Except for EB-L1060UNL / 1070UNL.

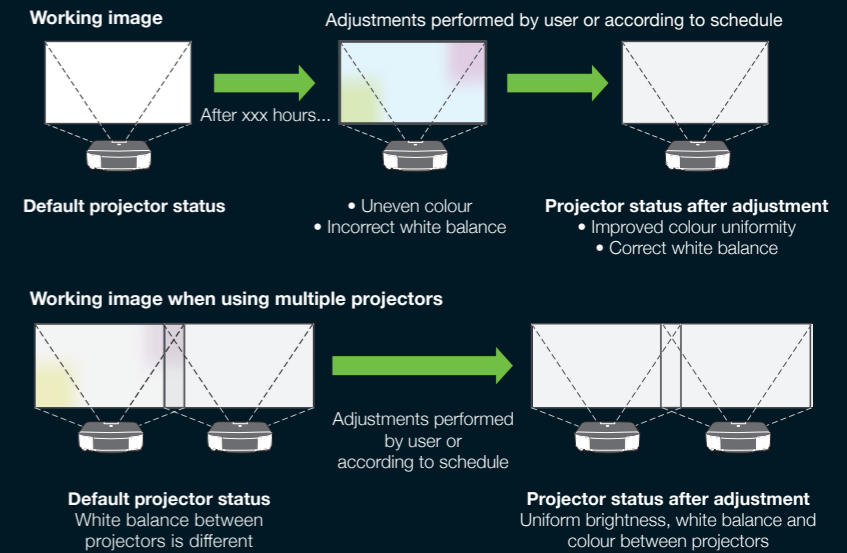

Super-resolution Technology

Epson's super-resolution technology delivers razor-sharp images even when projecting low-resolution content onto large screens. And with image data processed frame by frame, even rapid motion remains crisp.

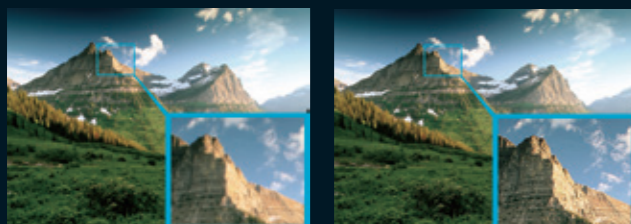

Super-resolution OFF

Super-resolution ON

Colour Adjustment

With the colour adjustment function, you can easily adjust the hue, saturation and brightness for each component of RGBCMY to match your preferences.

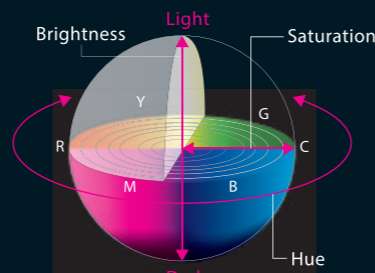

High Contrast

With high contrast of 2,500,000:1 or higher, it is possible to fully depict gradations even in dark-toned images.



Contrast Ratio 2,500,000:1

Adaptive Projections

Designed with greater flexibility to fit any venue and application.



Powered Lens with Stepping Motor

The motorized lens shift covers a wide range, giving you a great deal of flexibility when installing the projector. A newly adopted stepping motor lets you make highly precise adjustments when employing edge blending, stacking and other techniques.

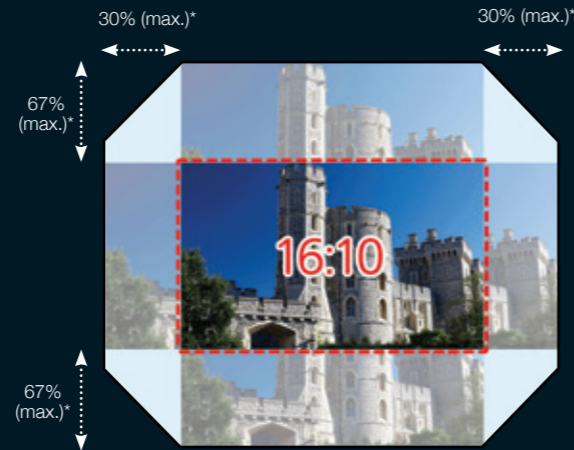

* ±60% vertically, ±18% horizontally for EB-L1505UHNL/EB-L1755UNL

Lens-position Memory

With storage for up to 10 settings in the projector memory, including shift positions, focus and projection sizes, you can easily and quickly adjust the projector according to the aspect ratio of content simply by using either the remote controller or command control.

Extensive Lens Options

The Epson EB-L1000 series offers an extensive line-up of optional lenses to fit any venue or subject. And with the ELPLX01/ELPLX01W and ELPLX02 zero offset, ultra-short throw lens, you can install the projector even in tight spaces.

LENS	EB-L1060UNL / L1070UNL		EB-L1495UNL / L1505UHNL / L1755UNL	
	WUXGA		WUXGA	
Specifications	Wide	Tele	Wide	Tele
ELPLX01/ELPLX01W	0.35		Not Applicable	
ELPLX02	Not Applicable		0.35	
ELPLU03S	0.65	0.78	0.48	0.57
ELPLU04	0.87	1.05	0.64	0.77
ELPLW05	1.04	1.46	0.77	1.07
ELPLW06	1.62	2.22	1.19	1.62
ELPLW08	1.16	1.63	0.86	1.21
ELPLM08	1.44	2.32	Not Applicable	
ELPLM15	2.16	3.48	1.57	2.56
ELPLM10	3.32	5.06	2.42	3.71
ELPLM11	4.85	7.38	3.54	5.41
ELPLL08	7.21	10.11	5.27	7.41

Zero Offset, Ultra-short Throw Lens

A revolutionary invention of Epson, these powerful lens, ELPLX01/ELPLX01W and ELPLX02, are especially useful for environments with extremely limited lens-to-screen distances. The short throw ratio of 0.35 with zero-offset and the projector's front-mounted exhaust system means you can project up to 1000-inch screens even from as near as 7.69m away. When combined with lens shift, these features simplify usage where space is at a premium.

17% Lens Shift (Larger image from shorter distances, plus added installation flexibility)

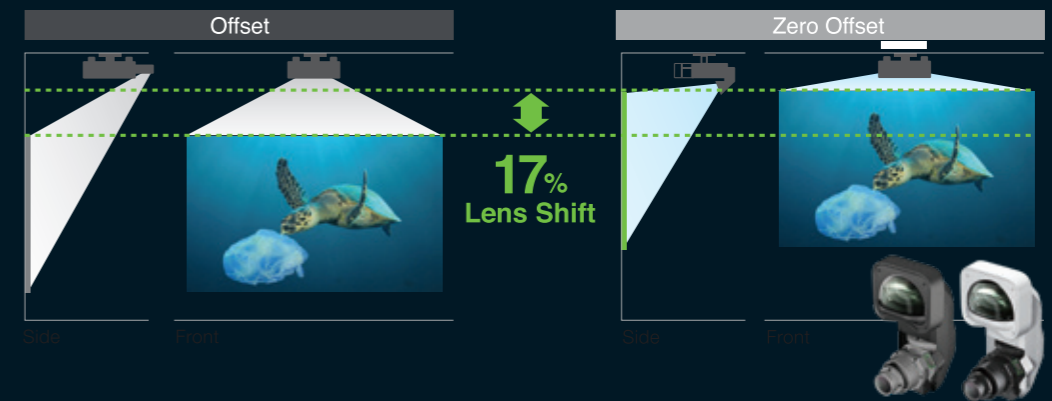

Projection on Wide Curved and Corner Spaces

Fit your projection images nicely even on non-flat surfaces. Create stunning projection images on wide curved surfaces and corner walls, ideal for advertisements and marketing promotions.



Borderless Multi Projection

Offering a variety of functions for multi-projector installations, the EB-L1000 series lets you adjust brightness, colour and the position of overlapping areas for seamless, beautiful displays. There is also an Auto Scaling function for easy multi-projector displays and an Advanced Edge Blending function for more precise edge-blending adjustment.

Colour Matching/Brightness Level

Enjoy uniform colour and brightness even when using multiple projectors.

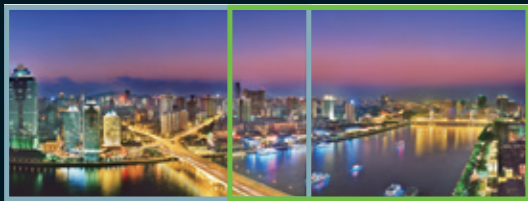

Point Correction

Easily correct single-projector distortion or multi-projector misalignment directly on the screen. Quickly fine-tune the images by adjusting point by point from right to left, top to bottom, using a projected maximum 17 x 17 matrix.



Black Level

Experience uniform black levels in overlapping areas of images even when using multiple projectors.



Advanced Edge Blending

Precisely adjust edge blending to combine multiple edges for a seamless, unified look. This function allows you to fine-tune the start position and edge width of the blend as well as the area of the black level in the blend. It also prevents the main subject from being overlapped. As a tip, you can reduce the size of the overlapping areas to decrease the time it takes to combine multiple images.

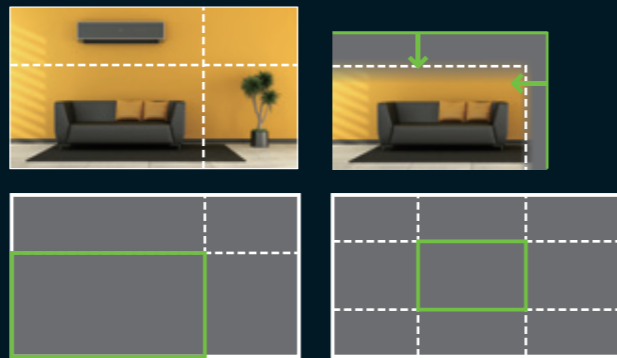

Auto Scaling

This revolutionary function simplifies the complicated scaling of images from multiple projectors so you can do it easily. Just select the screen layout from the pre-set menu and the projector automatically sets the slice area, scaling and edge-blend position.

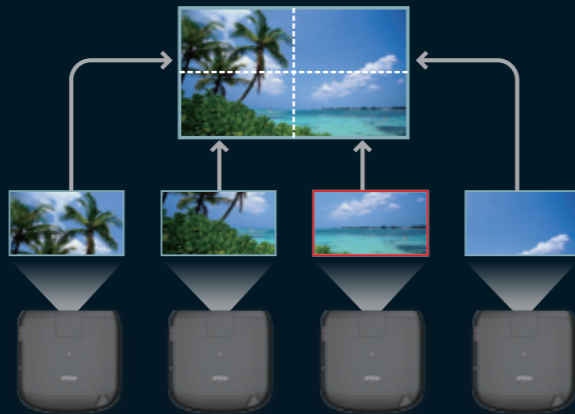

Wide Range of Connectivity

The Epson EB-L1000 series is compatible with a wide range of external devices, and additional ports now include DVI-D, HDMI, HDBaseT and SDI*. Ideal for large venues, HDBaseT can transmit Full HD video, audio and Ethernet at low cost through cat 5e/6 cables up to 100 metres.



* For EB-L1495UNL/EB-L1505UHNL/EB-L1755UNL only.

Ease of Maintenance

Epson Projector Management

Using Epson Projector Management, it allows you to monitor and control multiple network connected projectors (up to 2,000 units) using a computer with easy to use GUI. A projector's power status, irregularities, warnings, etc. can all be determined visually through the use of icons or you can choose to be notified by email of any projector anomalies.



Web Control

By connecting your projector to a network, you can adjust your projector installation entries from a PC or smart device.



Transfer OSD Information

Reduce installation and setup time when using multiple projectors by transferring OSD settings — such as brightness and colour settings as well as user logos — to multiple machines via USB or over a network.

Professional Softwares

Epson Projector Content Manager*

Free software that allows you to make playlist. You can edit playlist by

- Adding images and videos
- Setting a schedule
- Setting an overlay effect
- Exporting to USB memory

* Only for EB-L1060UNL / L1070UNL only.

STEPS

- 1 Add images or movies to a playlist
Schedule a playlist
Set a custom shape filter



- 2 Save to USB memory

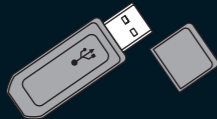

- 3 Project your playlist from the USB memory

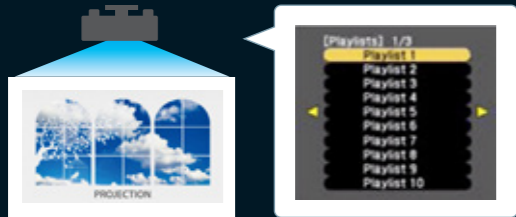

Epson Projector Professional Tool

Software for matching projected-image borders when multiple projectors are used is provided free of charge. If Epson Projector Professional Tool software is used, operations and settings that previously required separate remote controller operations for each projector can now all be done on a single PC, greatly reducing installation time and effort.



Note: Some functions do not support Epson Professional Tool. Network connections is a requirement for use of Epson Professional Tool.

Remote Camera Access

The camera capture function* allows administrators to preview errors on-screen remotely in real time simply by linking up to the same network used by the projector. This translates to faster support and minimal projector downtime.

* For EB-L1495UNL/L1505UHNL/L1755UNL only.



Built-in camera



EPSON REVOLUTIONISES PROJECTOR MARKET WITH 3LCD TECHNOLOGY AND LEADS AS WORLD'S NO.1* PROJECTOR BRAND FOR 17 CONSECUTIVE YEARS!

* Based on independent research by Futuresource Consulting



The device used to change blue laser light into yellow light. The adoption of an inorganic phosphor wheel has made it durable enough to withstand the high output of a laser light source.

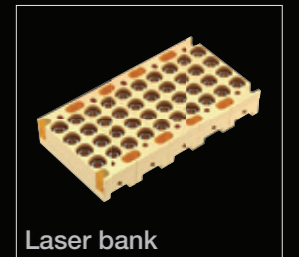

High-powered laser diodes enable to achieve the outstanding brightness-15,000lm.

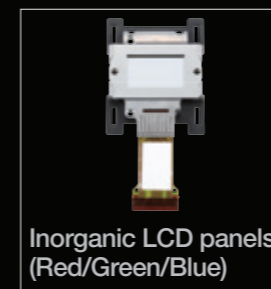

Newly developed, large 1.06inch panel. The adoption of an inorganic panel enhances light resistance and helps realise an even longer life.

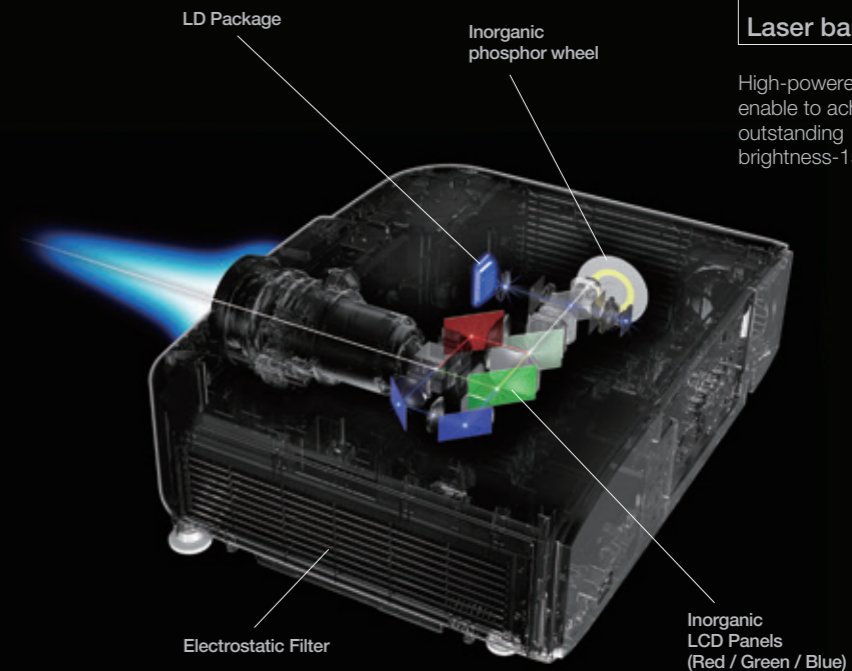

First, blue light from the laser is projected through a beam splitter, which divides the light into two beams: One beam is reflected by a phosphor wheel, where it is changed into yellow, while the other beam remains blue. The two beams are then recombined into white light.

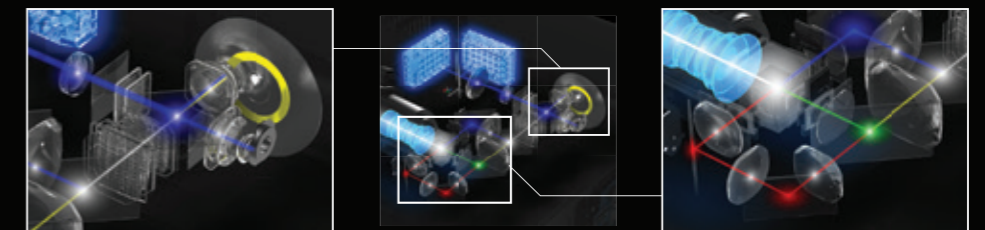

It is separated into red, green and blue through dichroic mirrors. After this, each of the three colours pass through LCD panels, producing three individual images. Lastly, these three images are transmitted through a prism and combined into the final full-colour image.

**PROJECTOR WISHES
COME TRUE.**

EPSON 3LCD PROJECTORS

1-CHIP PROJECTORS



Up to **3x**
Brighter Colours
with
Epson Projectors*

**TRUE
BRIGHTNESS**



WHITE 3000 LUMENS
COLOUR 3000 LUMENS

WHITE 3000 LUMENS
COLOUR 430 LUMENS**



**NO
RAINBOW
EFFECT**

**TRUE
COMFORT**



LIGHT SOURCE
PRISM

LIGHT SOURCE
ROTATING
COLOUR WHEEL



Up to **3x**
WIDER
COLOUR GAMUT*
Epson Projectors

**TRUE
REALISM**



WIDER
COLOUR
RANGE

SMALLER
COLOUR
RANGE

**TRUE
COLOURS**

Brighter, vivid projection from Epson.

9 out of 10
PEOPLE
PREFER
IMAGES FROM
EPSON
PROJECTORS



LENS SPECIFICATIONS
EB-L1060UNL/L1070UNL/L1495UNL
EB-L1505UHNL/L1755UNL

Expanded
Lens Suite



Product Image	Ultra Short Throw Lens (ELPLX01/ELPLX01W)	Ultra Short Throw Lens (ELPLX02)	Zoom Lens (ELPLU03S)	Zoom Lens (ELPLU04)	Zoom Lens (ELPLW05)	Zoom Lens (ELPLW06)
Model	Ultra Short Throw Lens (ELPLX01/ELPLX01W)	Ultra Short Throw Lens (ELPLX02)	Zoom Lens (ELPLU03S)	Zoom Lens (ELPLU04)	Zoom Lens (ELPLW05)	Zoom Lens (ELPLW06)
Product Code	V12H004X01/ V12H004Y01	V12H004X02	V12H004UA3	V12H004U04	V12H004W05	V12H004W06
Specification of Main Parts						
Projection Lens						
Type	Powered : Focus / Distortion		Powered : Zoom / Focus / Distortion		Powered : Zoom / Focus	
F-Number	1.9		2.0 - 2.3		2.0 - 2.2	
Focal Length	5.8mm		11.1 - 13.1 mm		17.6 - 24.3 mm	
Zoom Ratio	N/A		1 - 1.2		1 - 1.4	
Dimension (Diameter of Zoom Ring x Length)	215 x 321 x 164 mm		150 x 240 mm		135 x 200.5 mm	
Weight	3500g		1800g		1450g	
Lens Exchange Correspondence	Yes		Yes		Yes	
Screen Size	100" - 1,000" [0.74 - 7.82 m] Throw ratio 0.35	N/A	80" - 1,000" [1.11 - 14.32 m] (Zoom: Wide) 80" - 1,000" [1.34 - 17.17 m] (Zoom: Tele) Throw ratio 0.65 - 0.78	50" - 1,000" [0.91 - 19.34 m] (Zoom: Wide) 50" - 1,000" [1.11 - 23.24 m] (Zoom: Tele) Throw ratio 0.87 - 1.05	50" - 1,000" [1.09 - 23.17 m] (Zoom: Wide) 50" - 1,000" [1.55 - 32.01 m] (Zoom: Tele) Throw ratio 1.04 - 1.46	50" - 1,000" [1.729 - 35.69 m] (Zoom: Wide) 50" - 1,000" [2.35 - 48.58 m] (Zoom: Tele) Throw ratio 1.62 - 2.22
Lens Shift Range	Powered Vertical: +50% to +67% (H Center) Horizontal: ±10% (Vertical+50%)	N/A	Powered Vertical: ±67% (H Center) Horizontal: ±30% (V Center)	Powered Vertical: ±60% (H Center) Horizontal: ±18% (V Center)	Powered Vertical: ±24% (H Center) Horizontal: ±10% (V Center)	Powered Vertical: ±60% (H Center) Horizontal: ±18% (V Center)
Screen Size	N/A	100" - 1000" [0.74 - 7.69 m] Throw ratio 0.35	80" - 1,000" [0.8 - 10.45 m] (Zoom: Wide) 80" - 1,000" [0.97 - 12.56 m] (Zoom: Tele) Throw ratio 0.48 - 0.57	60" - 1,000" [0.80 - 14.15 m] (Zoom: Wide) 60" - 1,000" [0.97 - 17.02 m] (Zoom: Tele) Throw ratio 0.64 - 0.77	60" - 1,000" [0.94 - 16.97 m] (Zoom: Wide) 60" - 1,000" [1.35 - 23.44 m] (Zoom: Tele) Throw ratio 0.77 - 1.07	60" - 1,000" [1.49 - 26.06 m] (Zoom: Wide) 60" - 1,000" [2.06 - 35.44 m] (Zoom: Tele) Throw ratio 1.19 - 1.62
Lens Shift Range	N/A	Powered Vertical: +45% to +70% (H Center) Horizontal: ±15%	Powered Vertical: ±24% (H Center) Horizontal: ±10% (V Center)	Powered Vertical: ±60% (H Center) Horizontal: ±18% (V Center)	Powered Vertical: ±24% (H Center) Horizontal: ±10% (V Center)	Powered Vertical: ±60% (H Center) Horizontal: ±18% (V Center)
Operating Temperature	0 - 45 °C		0 - 45 °C		0 - 45 °C	
Storage Temperature	-10 - 60 °C		0 - 50 °C		0 - 50 °C	
Operating Angle of Tilt	360°		360°		360°	



EpsonSEA @EpsonSEA @EpsonSEA YouTube EpsonSoutheastAsia Epson Southeast Asia

Find out more at www.epson.com.sg/truecolours

IT'S IN THE DETAILS.

With 3LCD panels, every projection gives you spectacular true colours.

* Leading Epson business and education projectors vs. leading 1-chip DLP® projectors, selected according to NPD data as of July 2015. Based on U.S. research conducted by Radius Research.
** These lumen statistic can be found at www.colorlightoutput.com.
1 Color brightness(color light output) in brightest mode, measured by a third-party lab in accordance with IDMS 15.4. Color brightness will vary depending on usage conditions. Top-selling Epson 3LCD projectors versus top-selling 1-chip DLP® projectors based on NPD sales data for May 2017 - April 2018.
2 Gamut volume in brightest mode, measured by a third-party lab in 3D in the CIE L*a*b* coordinate space. Top-selling Epson 3LCD projectors versus top-selling 1-chip DLP® projectors based on NPD sales data for May 2017 - April 2018.

LENS SPECIFICATIONS
EB-L1060UNL/L1070UNL/L1495UNL
EB-L1505UHNL/L1755UNL



Product Image	Zoom Lens (ELPLW08)	Ultra Short Throw Lens (ELPLM08)	Zoom Lens (ELPLM10)	Zoom Lens (ELPLM11)	Zoom Lens (ELPLM15)	Zoom Lens (ELPLL08)	
Model	Zoom Lens (ELPLW08)	Ultra Short Throw Lens (ELPLM08)	Zoom Lens (ELPLM10)	Zoom Lens (ELPLM11)	Zoom Lens (ELPLM15)	Zoom Lens (ELPLL08)	
Product Code	V12H004W08	V12H004M08	V12H004M0A	V12H004M0B	V12H004M0F	V12H004L08	
Specification of Main Parts							
Projection Lens	Powered : Zoom / Focus / Distortion						
Type	Powered : Zoom / Focus						
F-Number	2.0 - 2.2	1.7 - 2.3	1.8 - 2.4	1.8 - 2.35	1.8 - 2.35	1.8 - 2.5	
Focal Length	19.7 - 27.5 mm	24.0 - 38.2 mm	55.4 - 83.3 mm	80.6 - 121.1 mm	36.0 - 57.4 mm	119.0 - 165.4 mm	
Zoom Ratio	1 - 1.4	1 - 1.6	1 - 1.5	1 - 1.6	1 - 1.6	1 - 1.4	
Dimension (Diameter of Zoom Ring x Length)	140 x 263.5 mm	115 x 191 mm	104 x 243 mm	104 x 245 mm	111.2 x 202 mm	104 x 247 mm	
Weight	3050g	1200g	2200g		1900g	2200g	
Lens Exchange Correspondence	Yes						
Screen Size	50" - 1,000" [1.24 - 25.78 m] (Zoom: Wide) 50" - 1,000" [1.75 - 36.11 m] (Zoom: Tele) Throw ratio 1.18 - 1.66	50" - 1,000" [1.53 - 31.57 m] (Zoom: Wide) 50" - 1,000" [2.48 - 50.44 m] (Zoom: Tele) Throw ratio 1.44 - 2.32	50" - 1,000" [3.52 - 72.87 m] (Zoom: Wide) 50" - 1,000" [5.38 - 110.17 m] (Zoom: Tele) Throw ratio 3.32 - 5.06	50" - 1,000" [5.11 - 106.76 m] (Zoom: Wide) 50" - 1,000" [7.84 - 161.17 m] (Zoom: Tele) Throw ratio 4.85 - 7.38	50" - 1,000" [2.29 - 47.22 m] (Zoom: Wide) 50" - 1,000" [3.72 - 75.81 m] (Zoom: Tele) Throw ratio 2.16 - 3.48	50" - 1,000" [7.61 - 158.34 m] (Zoom: Wide) 50" - 1,000" [10.74 - 220.82 m] (Zoom: Tele) Throw ratio 7.21 - 10.11	
Lens Shift Range	Powered Vertical: ±67% (H Center) Horizontal: ±30% (V Center)						
Screen Size	60" - 1,000" [1.09 - 18.76 m] (Zoom: Wide) 60" - 1,000" [1.54 - 26.39 m] (Zoom: Tele) Throw ratio 0.86 - 1.21	N/A	60" - 1,000" [3.06 - 53.13 m] (Zoom: Wide) 60" - 1,000" [4.73 - 80.86 m] (Zoom: Tele) Throw ratio 2.42 - 3.71	60" - 1,000" [4.45 - 77.85 m] (Zoom: Wide) 60" - 1,000" [6.86 - 118.07 m] (Zoom: Tele) Throw ratio 3.54 - 5.41	60" - 1,000" [1.99 - 34.43 m] (Zoom: Wide) 60" - 1,000" [3.26 - 55.63 m] (Zoom: Tele) Throw ratio 1.57 - 2.56	60" - 1,000" [6.64 - 115.62 m] (Zoom: Wide) 60" - 1,000" [9.41 - 161.74 m] (Zoom: Tele) Throw ratio 5.27 - 7.41	
Lens Shift Range	Powered Vertical: ±60% (H Center) Horizontal: ±18% (V Center)						
Operating Temperature	0 - 50 °C						
Storage Temperature	-10 - 60 °C						
Operating Angle of Tilt	360°						

EB-L1060UNL / L1070UNL

EB-L1495UNL / L1505UHNL / L1755UNL

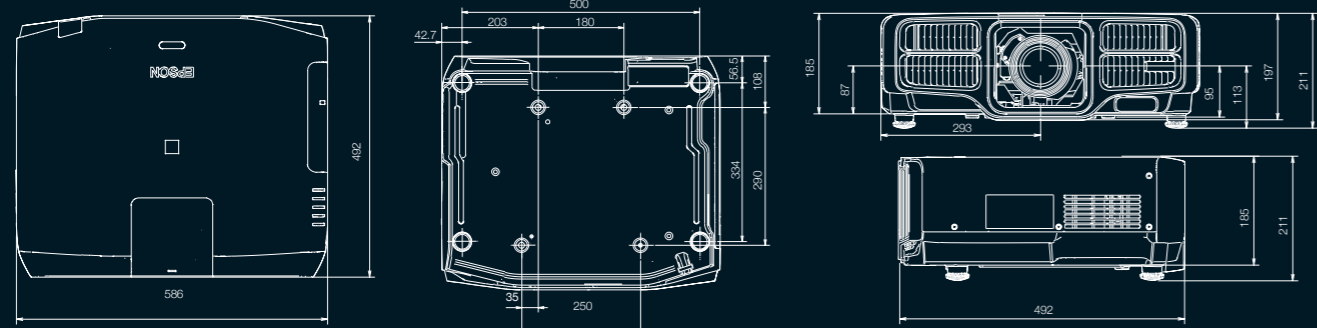

EB-L1495UNL / L1505UHNL / L1755UNL

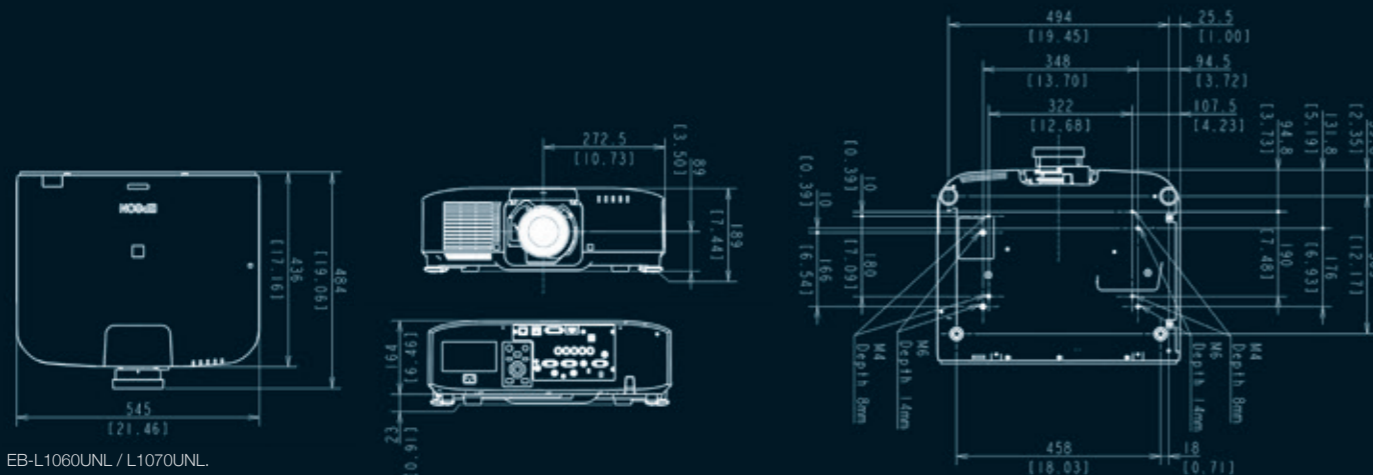

EB-L1060UNL / L1070UNL

CAD DRAWING

SPECIFICATIONS
EB-L1060UNL/L1070UNL/L1495UNL

MODEL NUMBER	EB-L1060UNL	EB-L1070UNL	EB-L1495UNL
Projection Technology	RGB liquid crystal shutter projection system (3LCD)		
Specifications of Main Parts			
LCD	Size: 0.76" (C2fine) Native Resolution: WUXGA (1920 x 1200) 1.03" (D10) WUXGA (1920 x 1200)		
Projection Lens	Type: Power Zoom / Power Focus / Power Shift F-Number: 1.7 - 2.3 Focal Length: 24.0 - 38.2 mm Zoom Ratio: 1 - 1.6 Throw Ratio: 1.44 - 2.33 (Wide to Tele) Lens Exchange: Yes Lens Shift: Mode: Powered Vertical (Up/Down): ±67% Horizontal (Left/Right): ±30%		
Lightsources	Type: Laser Diode Life (Normal / Long): 20,000 / 30,000 hours		
Screen Size (Projected Distance)	Zoom: Wide: 50" - 1,000" [1.53 - 31.57 m] Zoom: Tele: 50" - 1,000" [2.48 - 50.44 m] 60" - 1,000" [1.99 - 34.43 m] 60" - 1,000" [3.26 - 55.63 m]		
Brightness¹	White Light Output (Normal / Extended): 6,000lm / 4,200lm Colour Light Output: 6,000lm 7,000lm / 4,900lm 9,000lm / 6,300lm 9,000lm		
Contrast Ratio	Over 2,500,000:1		
Internal Speaker(s)	Sound Output: NA		
Geometric Correction	Vertical / Horizontal Keystone: ±45° / ±30° (Zoom: Tele) (with Standard Lens) Quick Corner: Yes Curve Surface: Yes Point Correction: Yes Corner Wall: Yes		
Connectivity	Analog Input: D-Sub 15Pin: 1 (Blue) 5BNC: 1 Digital Input: DVI-D: 1 HDMI: 1 (with HDCP 2.2) HDBaseT (RX): RJ45 x 1 (with HDCP 2.2) Output Terminal: BNC (SDI): N/A D-Sub 15Pin: 1 Audio Input: Stereo Mini Jack: 3 Audio Output: Stereo Mini Jack: 1 Others: USB Type A: 1 (for Wireless LAN, Firmware Update, Copy OSD Settings and Content Playback?) 1 (Wireless LAN, Firmware Update, Copy OSD Settings) USB Type B: 1 (for Firmware Update, Copy OSD Settings) Control I/O: RS-232C: D-Sub 9Pin x 1 Remote Control Input: Stereo Mini Jack x 1 Network: Wired LAN: RJ45 x 1 (100Mbps) Wireless: Optional RJ45 x 1 (100Mbps with Art-Net Support)		
Wireless Specification	Supported Speed For Each Mode: IEEE 802.11b: 11Mbps ² / IEEE 802.11g: 54Mbps ³ / IEEE 802.11n: 130Mbps ³ Wireless Security: Quick: Open, WPA2-PSK / Advanced: Open, WPA/WPA2-PSK, WPA/WPA2-EAP Supported EAP type: PEAP, PEAP-TLS, EAP-TLS, EAP-Fast, LEAP		
Operating Temperature	0 - 45 °C <32 - 113 °F> (Below 2,286m / 7,500ft) 0 - 40 °C <32 - 104 °F> (Over 2,286m / 7,500ft) (with high altitude mode) 0 - 50 °C <32 - 122 °F> (Below 1,500m / 4,921ft) 0 - 45 °C <32 - 113 °F> (Above 1,500m / 4,921ft - 3,048m / 10,000ft)		
Operating Altitude	0 - 3,048 m <0 - 10,000 ft> (over 1,500m / 4,921ft : with high altitude mode)		
Direct Power On / Off	Yes		
Start-Up Period	Less than 7 seconds, Warm-up Period: 30 seconds		
Cool Down Period	Instant Off		
Air Filter	Type: High Efficiency Filter Maintenance Cycle: 20,000 hours ⁴		
Power Supply Voltage	100 - 240 V AC ±10%, 50/60 Hz		
Power Consumption (220 - 240V)	Laser Diode (Normal / Extended): 345W / 252W 416W / 299W 626W / 512W Standby (Network On / Off): 2.0W / 0.50W 2W / 0.3W		
Dimension Excluding Feet (D X W X H)	436 x 545 x 164 mm 492 x 586 x 185 mm		
Weight (Including Standard Lens)	Approx. 16.9kg Approx. 23.7kg		
Weight (Excluding Standard Lens)	Approx. 15.6kg Approx. 21.9kg		
Fan Noise (Normal / Eco)	34dB / 30dB 36dB / 30dB 37dB / 30dB		

¹ Colour brightness (colour light output) and white brightness (white light output) will vary depending on usage conditions. Colour light output measured in accordance with IDMS 15:4; white light output measured in accordance with ISO 21118.
² For EB-L1060UNL / 1070UNL only.
³ Maximum speed and range is achievable when used with same enhanced mode technology. Actual data rates, features and performance may vary depending on your computer system, the environment and other factors.
⁴ 20,000H life for laser light source : Approximate time until brightness decreases 50% from first usage. Measured by acceleration test assuming use of 0.04 - 0.20 mg/m³ of particulate matter. Time varies depending on usage conditions and environments. Replacement of parts other than the light source may be required in a shorter period.

- Supplied Accessories**
Power Cable
HDMI Cable Clamp (For EB-L1495UNL)
Remote Control with 2 x AA Battery
Cable Cover
Lens Connector Cap
User's Manual CDROM
- Optional Accessories**
Air Filter: ELPAF51*, ELPAF46*
Wireless LAN Card: ELPAP10
HDBaseT Transmitter: ELPHD01
Remote Control Cable Set: ELPKC28
Ceiling Mount: ELPMB47 / ELPMB48
- Optional Lenses**
Ultra Short Throw Lens: ELPLX01* / ELPLX01W* / ELPLX02**
Zoom Lens: ELPLU03S / ELPLU04 / ELPLW05 / ELPLW06 / ELPLM08* / ELPLM10 / ELPLM11 / ELPLM15 (NEW) / ELPLL08 / ELPLW08**
- * Except EB-L1495UNL.
** For EB-L1495UNL only.

- EB-L1060UNL / EB-L1070UNL
- EB-L1495UNL



©2019 Epson Singapore Pte Ltd. All Rights Reserved. Reproduction in part or in whole, without the written permission from Epson, is strictly prohibited.
EPSON and EXCEED YOUR VISION are registered trademarks of Seiko Epson Corporation.
All other product names and other company names used herein are for identification purposes only and are the trademarks or registered trademarks of their respective owners.
Epson disclaims any and all rights in those marks. Projected images shown herein are simulations. The actual product design and contents may vary. Specifications are subject to change without notice and may vary between countries. Please check with local Epson offices for more information.
Apple, iPad and iPhone are trademarks of Apple Inc., registered in the U.S. and other countries. App Store is a service mark of Apple Inc.
Android is a trademark of Google Inc.

Dealer's Stamp

Information correct at time of printing
Printed December 2019